



INSTALLATION GUIDE

MELVILLE™ WALL
L-SHAPED KITCHEN



BLOCK MATRIX

		LENGTH	WIDTH	THICK	ROW 1	ROW 2	ROW 3	ROW 4	ROW 5	ROW 6	ROW 7	ROW 8	ROW 9	ROW 10	ROW 11	ROW 12	ROW 13	TOTAL	
BRICKS	A	20"	10"	4"	25	23	23	23	23	23	23	24	21	22	12			242	
	B	19.5"	10"	4"									2					2	
	C	15.5"	10"	4"		1												1	
	D	10"	10"	4"			1	1	1	1	1	1	1	1	2				9
	E	9.5"	10"	4"										2					2
	F	5.5"	10"	4"		1													1
	G	5"	10"	4"									2			1			3
	H	3"	10"	4"	2	3	2	2	2	2	2	2	2	2	2				21
CAPS	K	47.75"		0.75"												2	2	4	
	L	35.75"		0.75"												1		1	
	M	35.75"		0.75"												1		1	
	N	35.75"		0.75"												1		1	
	P	32.375"		0.75"													1	1	
	R	31"		0.75"												1		1	
	S	30.375"		0.75"												1		1	

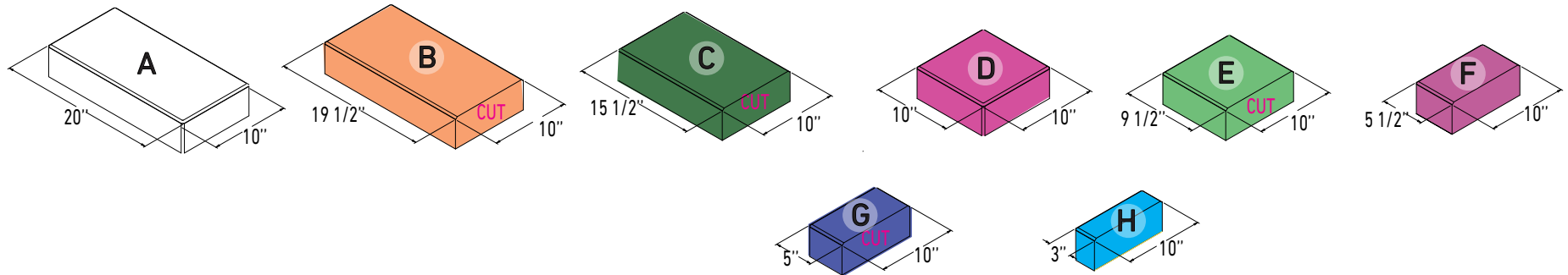

STEP 1 - ROW 1 BASE

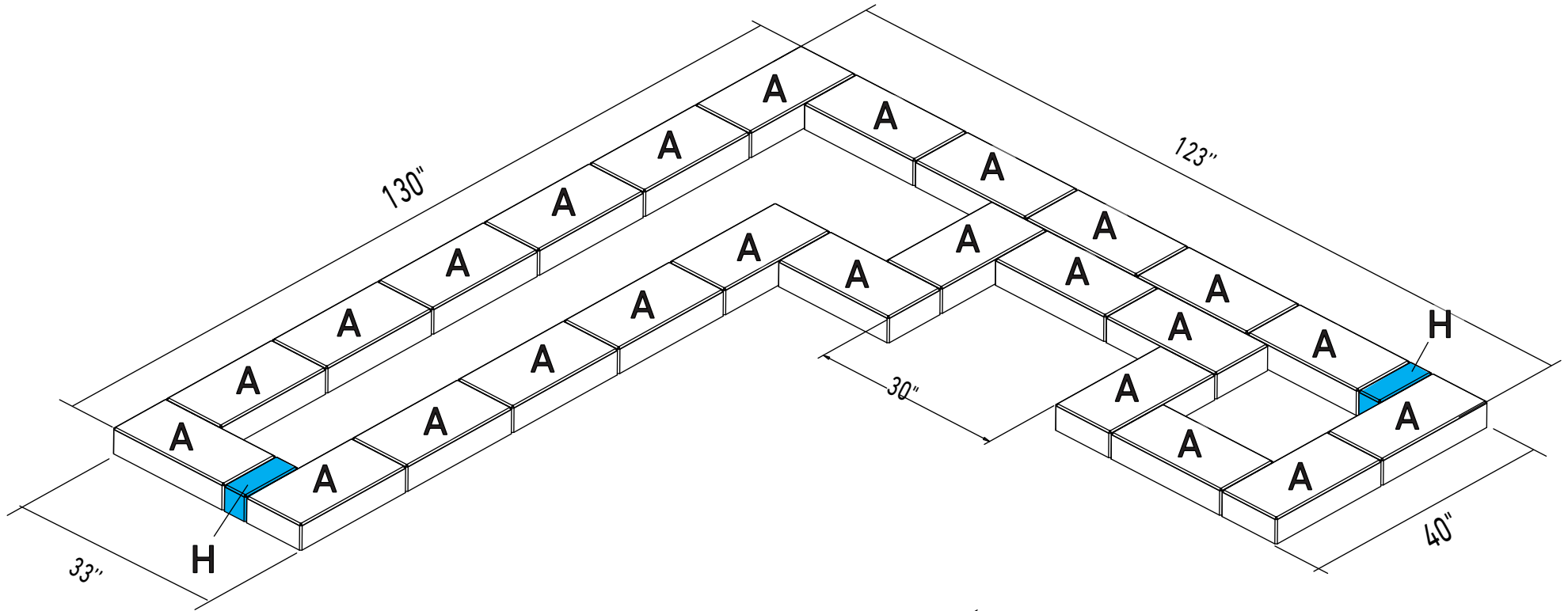

INSTRUCTIONS

1. Create a level base to build unit on top of. Leave a minimum of 6 -12" of gap behind grill unit to allow for venting.
2. Lay block on prepared base according to diagram. Glue beam blocks end to end for support beam and set aside for future use. Make sure it's clamped tightly together on a solid level surface.

Opening on right side will be for shelving or additional storage.

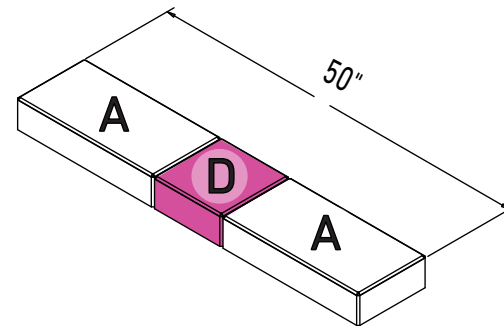

BOND BRICKS AT STEP 1 TO INSTALL AT STEP 8

STEP 2 - ROW 2

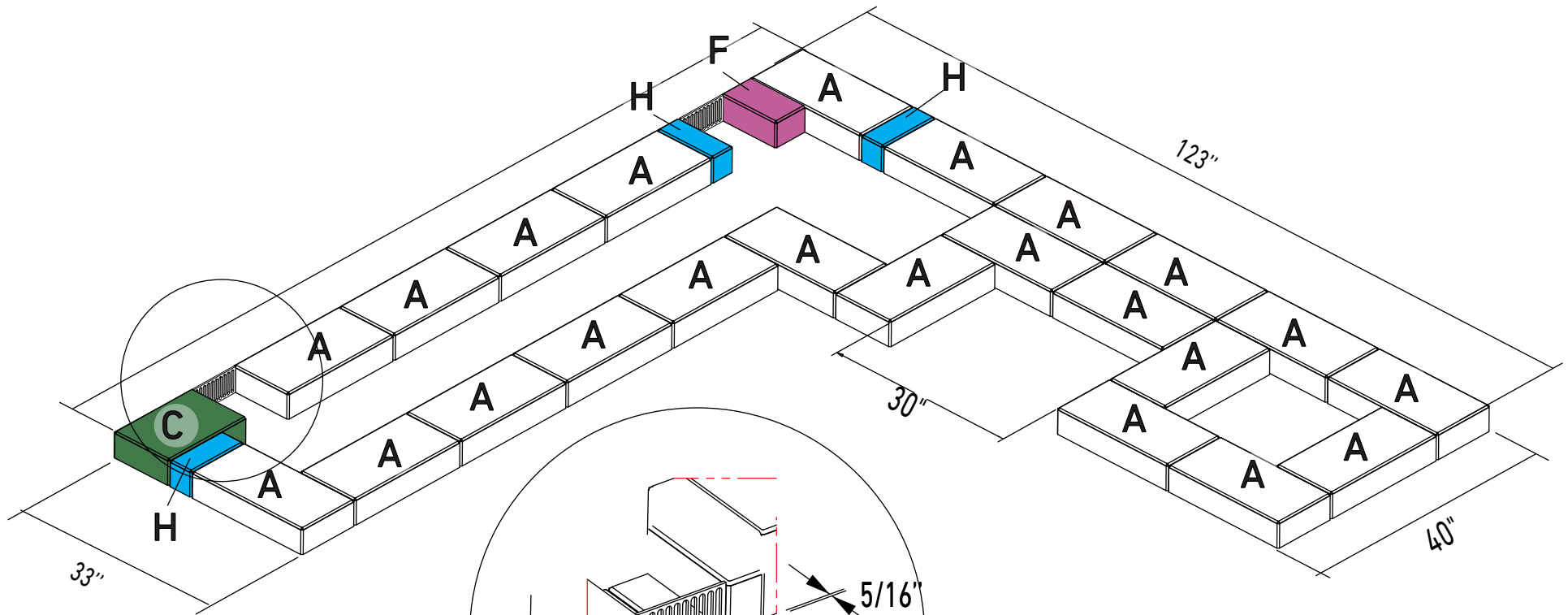

INSTRUCTIONS

1. Layout the next row on top according to pattern shown.
2. Modify venting plate to fill gap as shown.
3. Glue block in place and mount vent as shown. Opening is left for fridge.
4. Make sure units are square and level. Place cut ends against another block and not exposed. *Exposed ends are ok to be seen in vent cavity*

STEP 3 - ROW 3

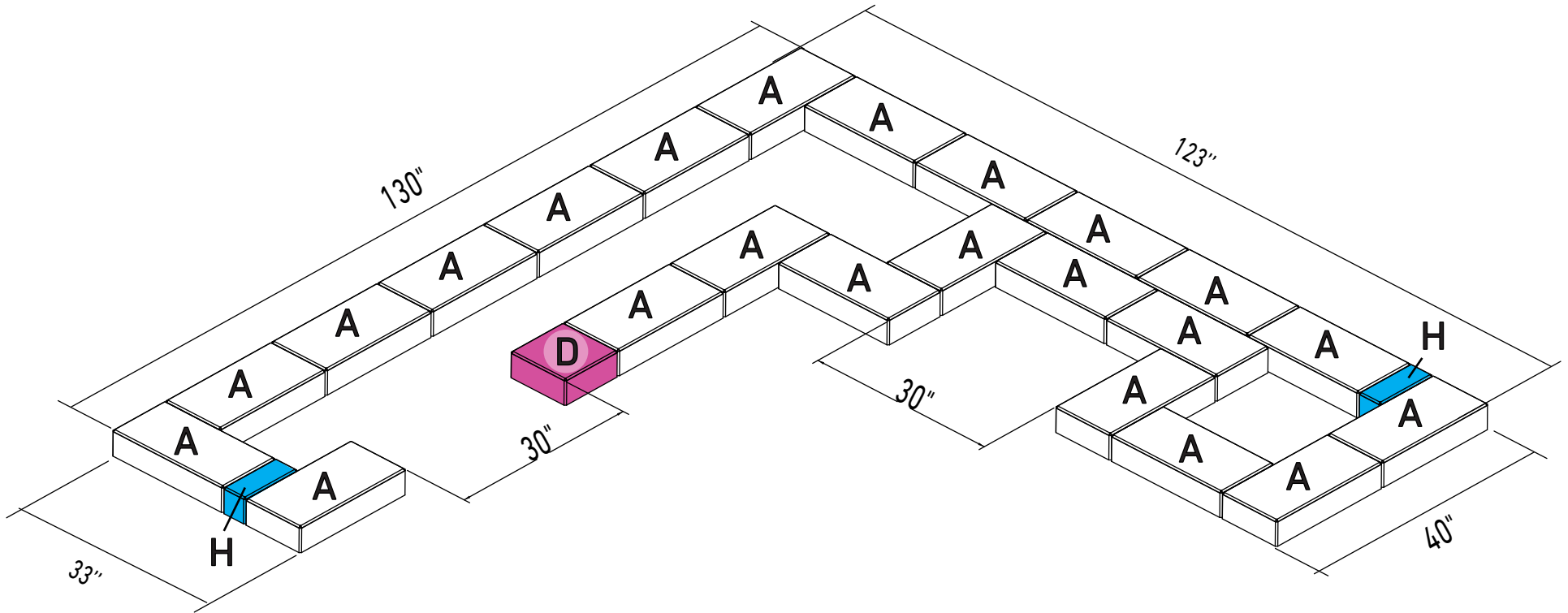

INSTRUCTIONS

1. Layout the next row on top of previous row according to pattern shown.
2. Openings are left for storage access.
3. Glue block to prior row after checking that it's level and square. Verify opening sizes.

**Rows 3, 5, and 7 are the same laying pattern.*

STEP 4 - ROW 4

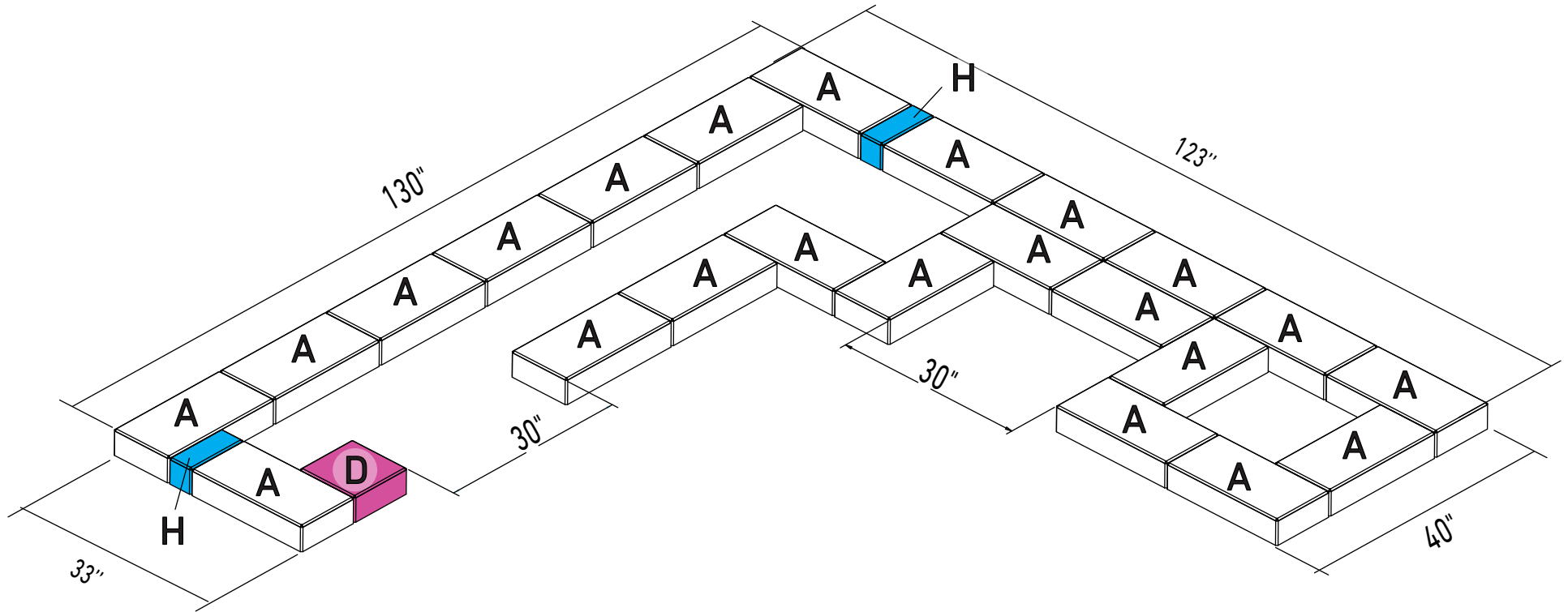

INSTRUCTIONS

1. Layout row according to diagram.
2. Glue block in place. Verify row is square and level.
Opening should be consistent.

Rows 4 and 6 are the same pattern

STEP 5 - ROW 5

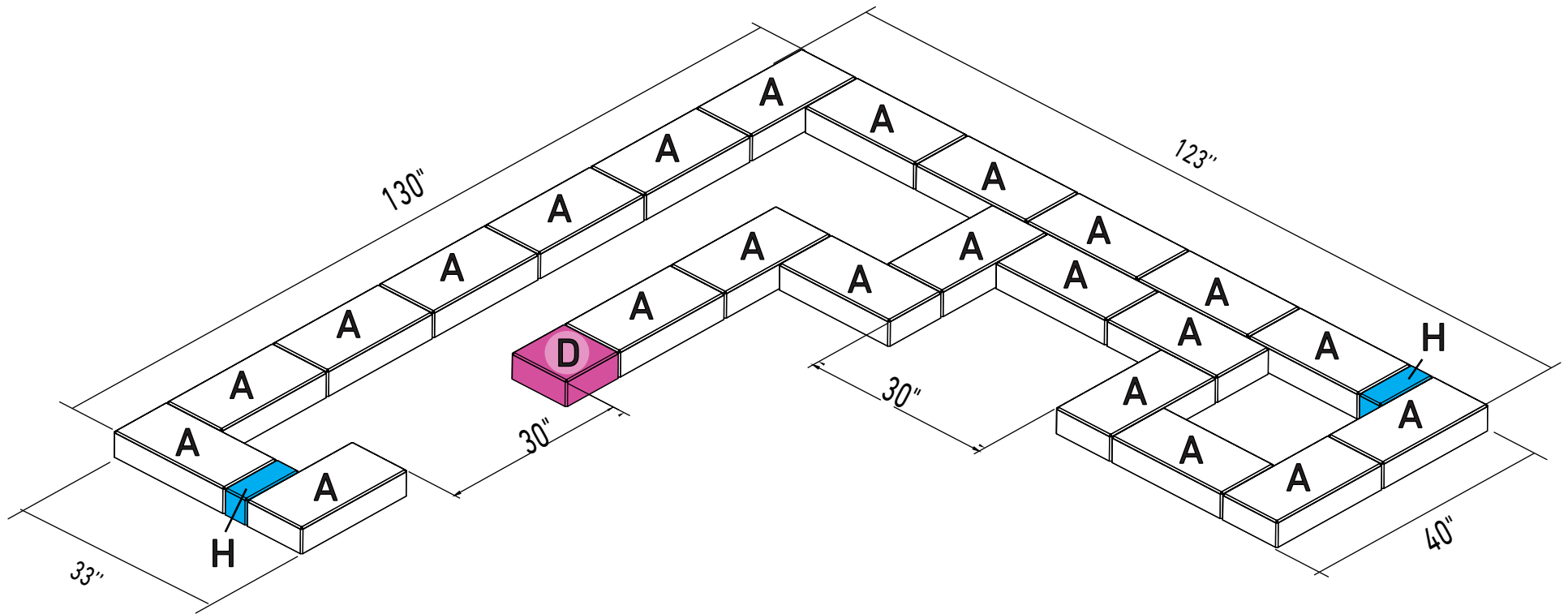

INSTRUCTIONS

1. Layout the next row on top of previous row according to pattern shown.
2. Openings are left for storage access.
3. Glue block to prior row after checking that it's level and square. Verify opening sizes.

**Rows 3, 5, and 7 are the same laying pattern.*

STEP 6 - ROW 6

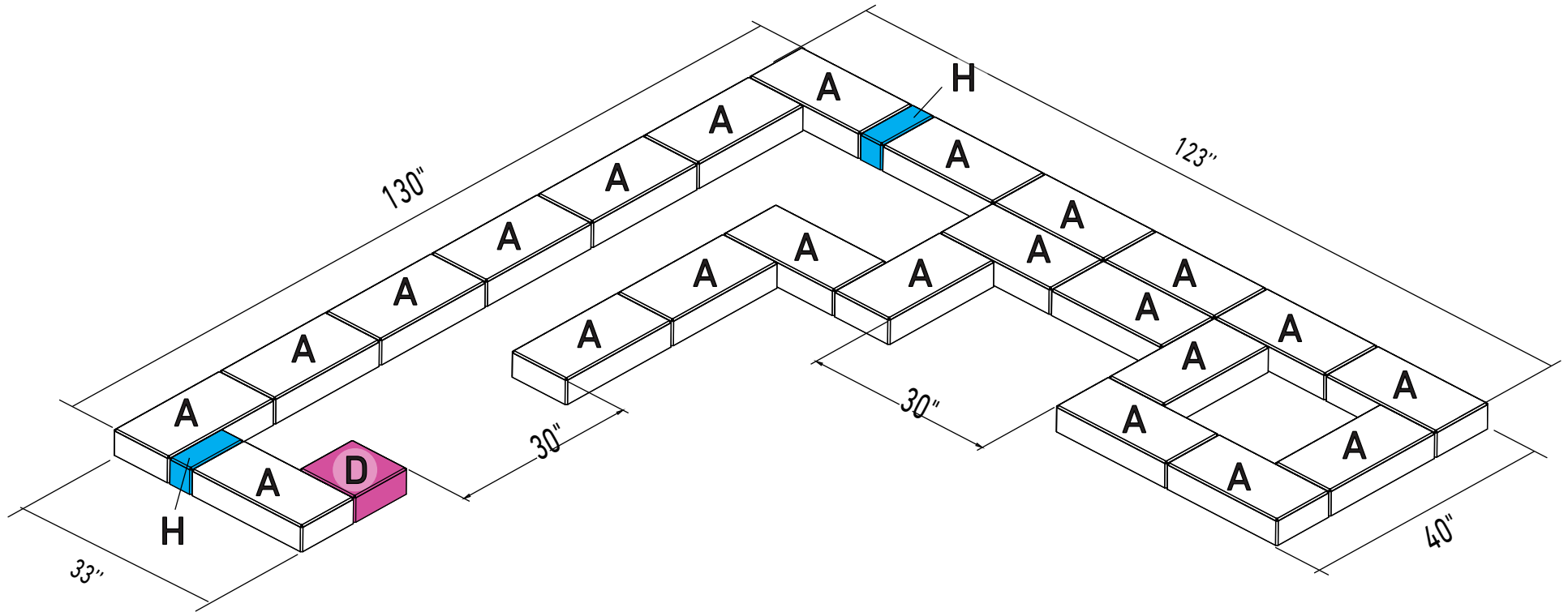

INSTRUCTIONS

1. Layout row according to diagram.
2. Glue block in place. Verify row is square and level.
Opening should be consistent.

Rows 4 and 6 are the same pattern

STEP 7 - ROW 7

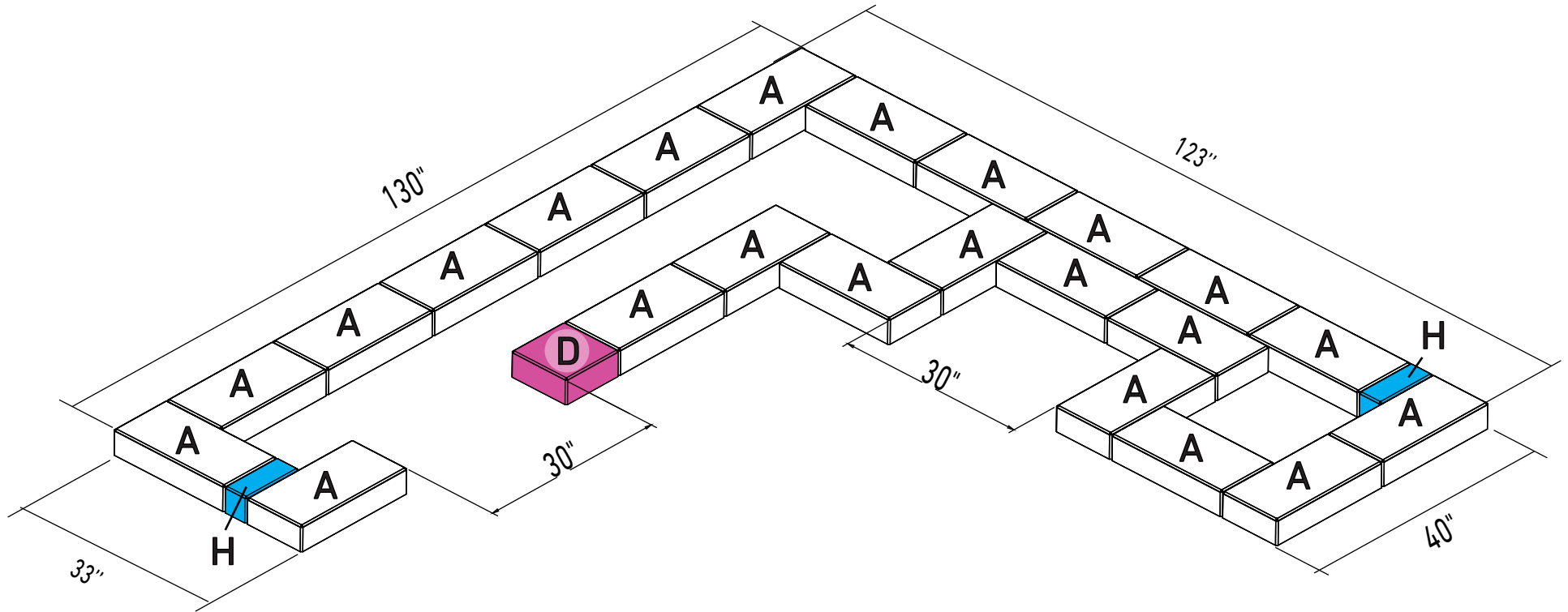

INSTRUCTIONS

1. Layout the next row on top of previous row according to pattern shown.
2. Openings are left for storage access.
3. Glue block to prior row after checking that it's level and square. Verify opening sizes.

**Rows 3, 5, and 7 are the same laying pattern.*

STEP 8 - ROW 8

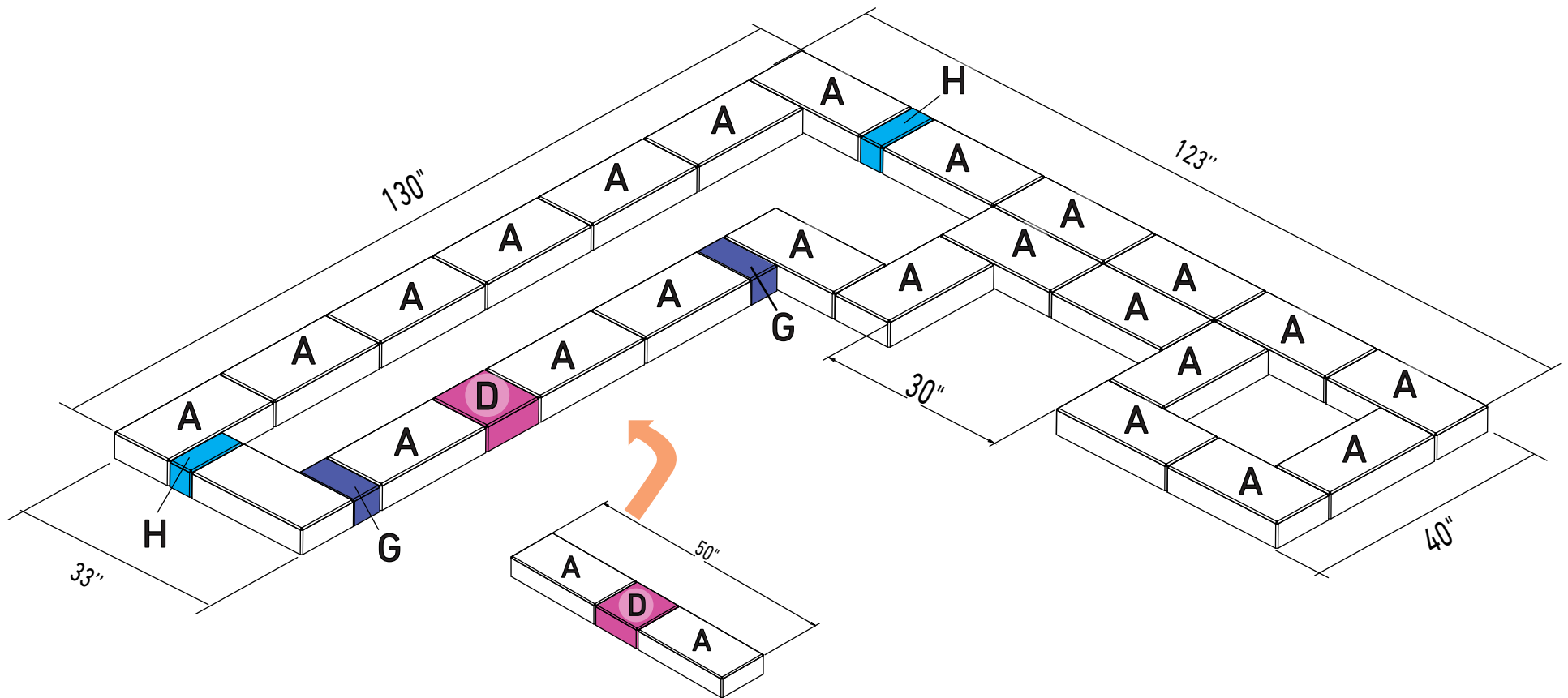

INSTRUCTIONS

1. Layout row according to diagram.
2. Beam blocks were glued together in step 1. Place beam over opening according to diagram. Make sure row is level and square.

STEP 9 - ROW 9

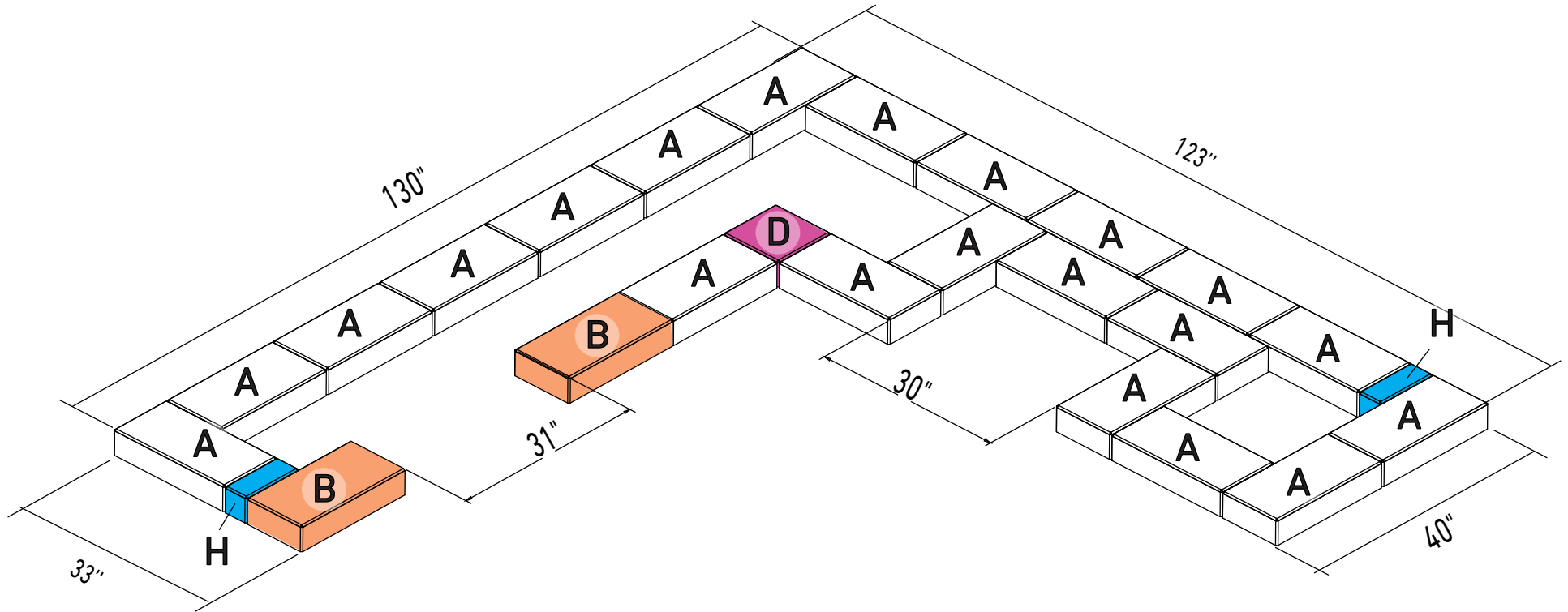

INSTRUCTIONS

1. Layout row according to diagram.
2. Grill head opening is created in this step. *Please note opening sizes as shown.*

STEP 10 – ROW 10

LATER 10

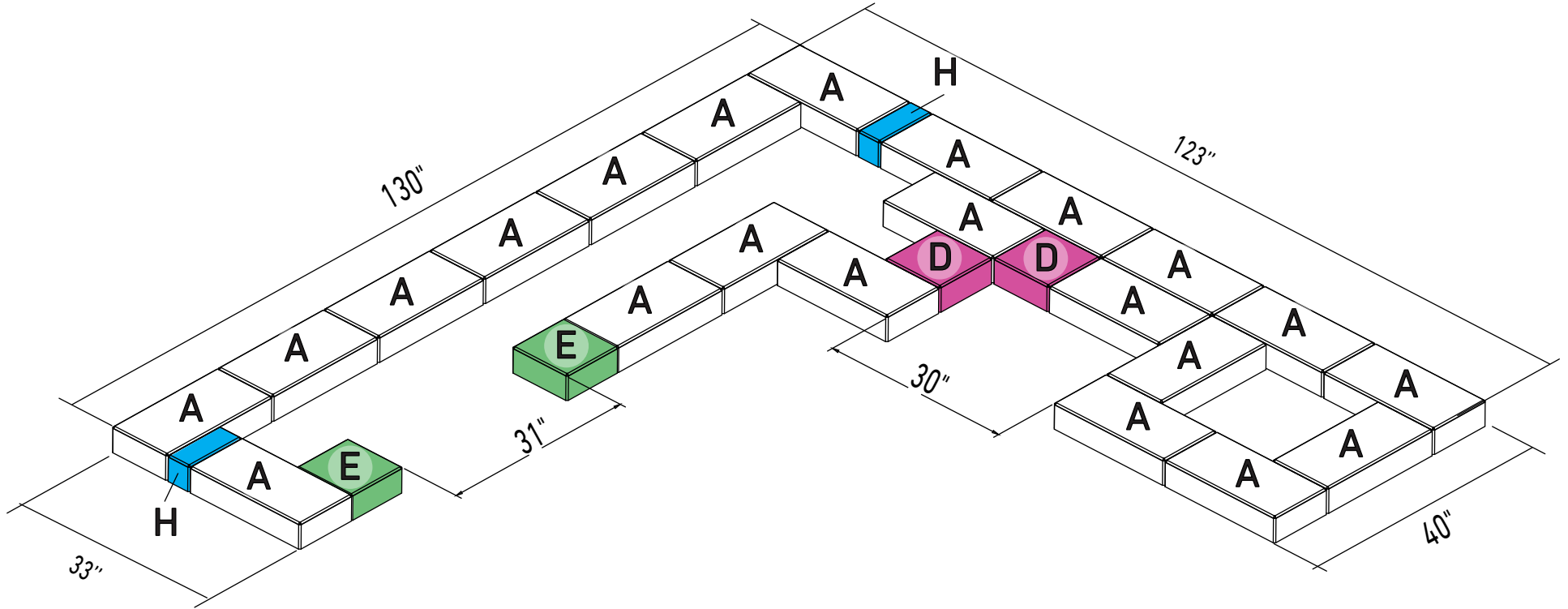

INSTRUCTIONS

1. Layout row according to diagram.
2. Glue block to previous row. Make sure row is level and square.

STEP 11 - ROW 11

COUNTERTOP

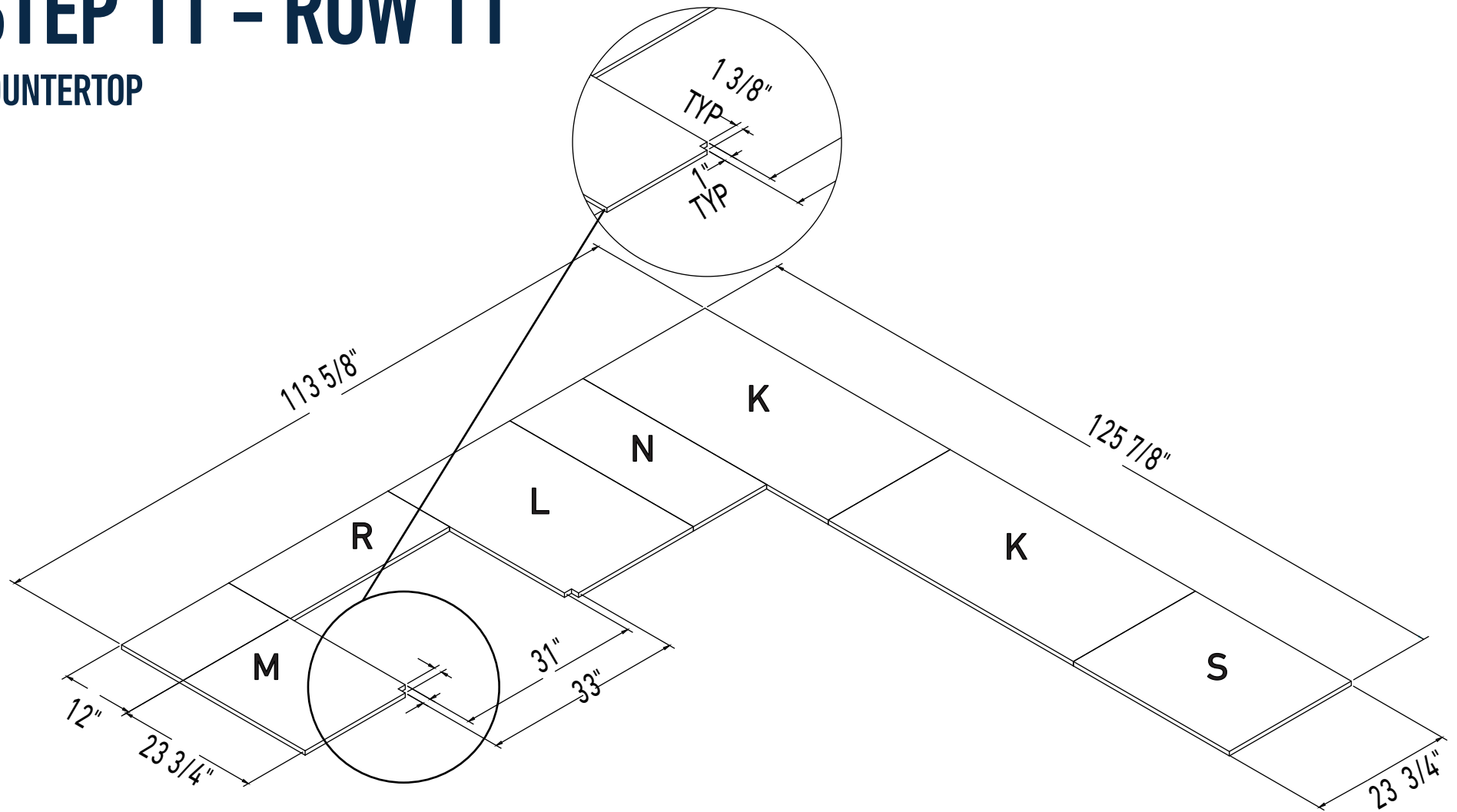

INSTRUCTIONS

1. Layout countertop according to diagram provided. Overhang is 1 3/8" on all sides.
2. Once fitment is verified, remove each piece one by one and apply glue.

The back center piece (behind rrill opening) will need a block set on top of it while it cures as a counter weight.

STEP 12 – ROW 12

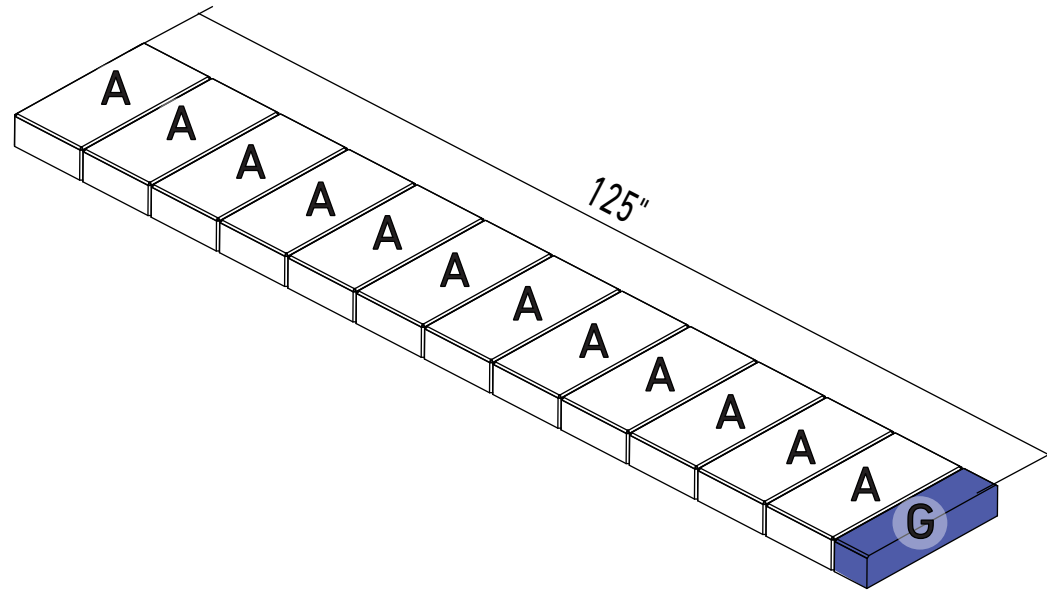

INSTRUCTIONS

1. Layout row according to diagram.
2. Glue block to previous row. Make sure row is level and square.

STEP 12 – ROW 12

LEDGE COUNTERTOP

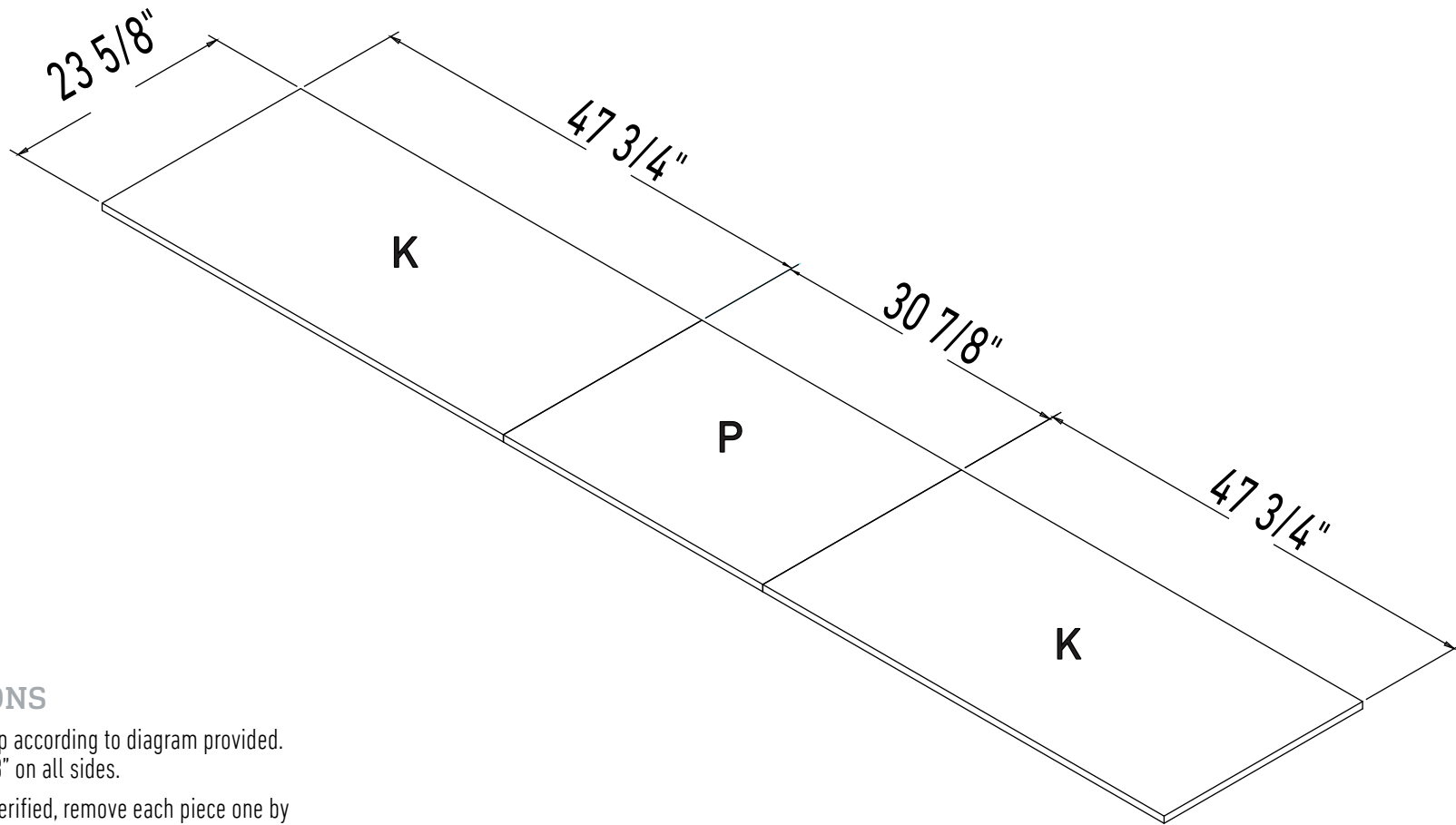

INSTRUCTIONS

1. Layout countertop according to diagram provided. Overhang is $1 \frac{3}{8}$ " on all sides.
2. Once fitment is verified, remove each piece one by one and apply glue.

The back center piece (behind grill opening) will need a block set on top of it while it cures as a counter weight.

COMPLETED UNIT (WITHOUT COUNTERTOP)

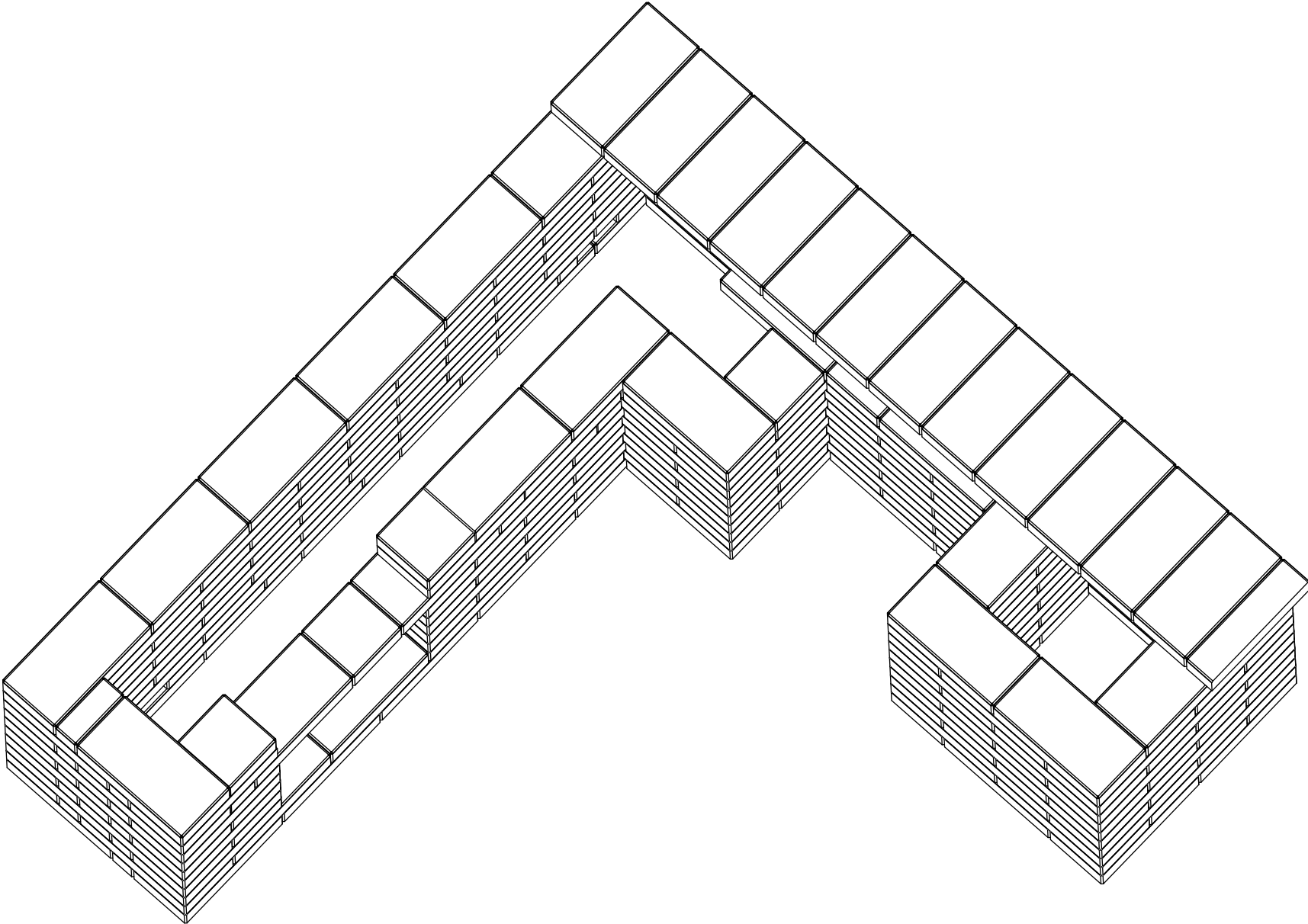

COMPLETED UNIT (TOP VIEW)

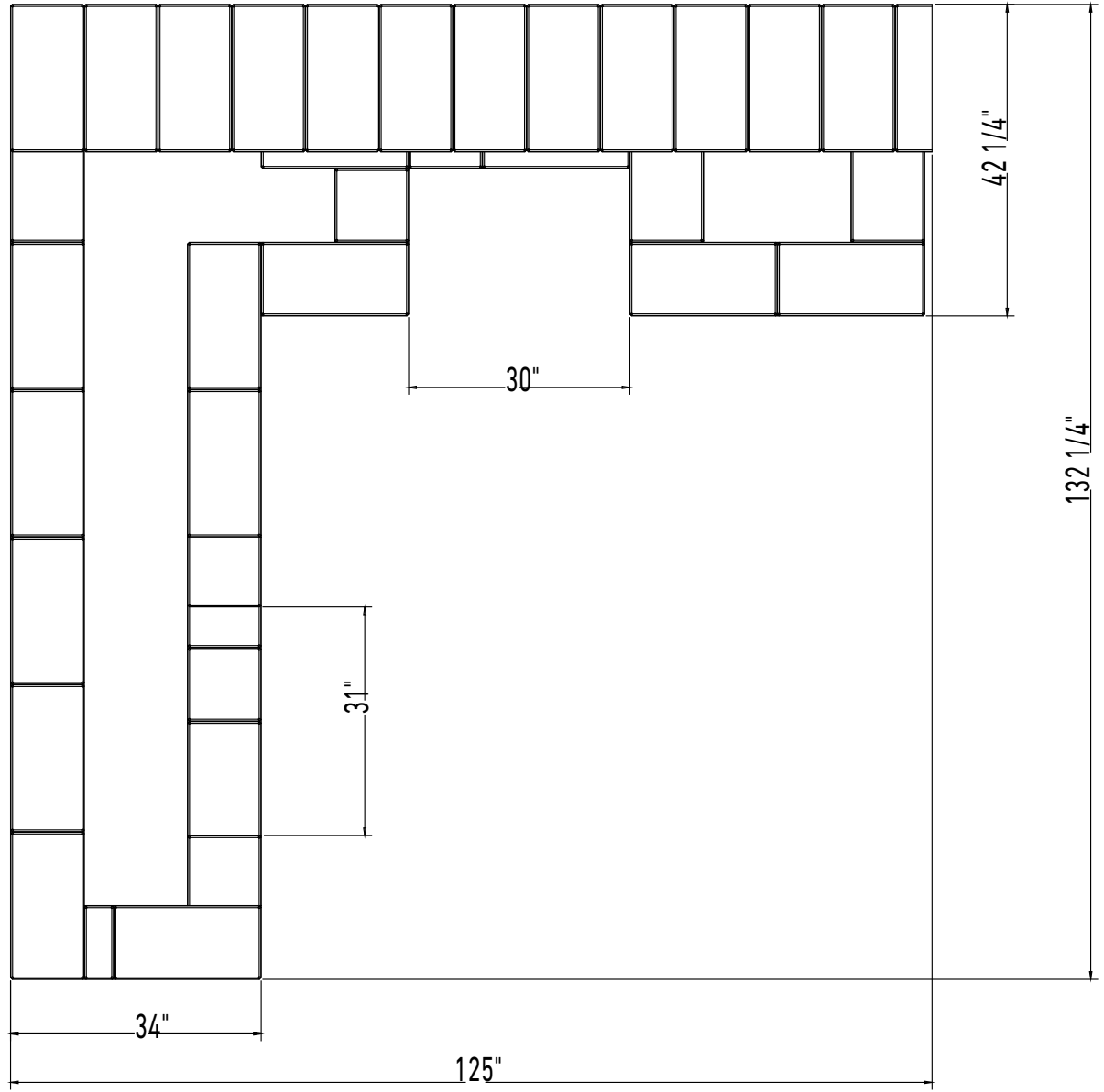



BELGARD.COM